



MODEL D3274
GRAVITY FEED SPRAY
GUN W/REGULATOR



OWNER'S MANUAL

Phone: (360) 734-3482 • Online Technical Support: tech-support@shopfox.biz

COPYRIGHT © JULY, 2008 BY WOODSTOCK INTERNATIONAL, INC.
WARNING: NO PORTION OF THIS MANUAL MAY BE REPRODUCED IN ANY SHAPE OR FORM WITHOUT
THE WRITTEN APPROVAL OF WOODSTOCK INTERNATIONAL, INC.

#10833JM PRINTED IN CHINA

 **WARNING!**

This manual provides critical safety instructions on the proper setup, operation, maintenance and service of this machine/equipment.

Failure to read, understand and follow the instructions given in this manual may result in serious personal injury, including amputation, electrocution or death.

The owner of this machine/equipment is solely responsible for its safe use. This responsibility includes but is not limited to proper installation in a safe environment, personnel training and usage authorization, proper inspection and maintenance, manual availability and comprehension, application of safety devices, blade/cutter integrity, and the usage of personal protective equipment.

The manufacturer will not be held liable for injury or property damage from negligence, improper training, machine modifications or misuse.

 **WARNING!**

Some dust created by power sanding, sawing, grinding, drilling, and other construction activities contains chemicals known to the State of California to cause cancer, birth defects or other reproductive harm. Some examples of these chemicals are:

- Lead from lead-based paints.
- Crystalline silica from bricks, cement and other masonry products.
- Arsenic and chromium from chemically-treated lumber.

Your risk from these exposures varies, depending on how often you do this type of work. To reduce your exposure to these chemicals: Work in a well ventilated area, and work with approved safety equipment, such as those dust masks that are specially designed to filter out microscopic particles.

SAFETY

WARNING

For Your Own Safety Read Instruction Manual Before Operating This Equipment

The purpose of safety symbols is to attract your attention to possible hazardous conditions. This manual uses a series of symbols and signal words which are intended to convey the level of importance of the safety messages. The progression of symbols is described below. Remember that safety messages by themselves do not eliminate danger and are not a substitute for proper accident prevention measures.

DANGER

Indicates an imminently hazardous situation which, if not avoided, **WILL** result in death or serious injury.

WARNING

Indicates a potentially hazardous situation which, if not avoided, **COULD** result in death or serious injury.

CAUTION

Indicates a potentially hazardous situation which, if not avoided, **MAY** result in minor or moderate injury. It may also be used to alert against unsafe practices.

NOTICE

This symbol is used to alert the user to useful information about proper operation of the equipment.

WARNING

Safety Instructions for Pneumatic Tools

1. **KEEP ALL SAFETY DEVICES IN PLACE** and in working order.
2. **REMOVE ADJUSTING KEYS AND WRENCHES.** Form habit of checking to see that keys and adjusting wrenches are removed from tool before operation.
3. **KEEP WORK AREA CLEAN.** Cluttered areas and benches invite accidents.
4. **DO NOT USE IN DANGEROUS ENVIRONMENT.** Do not use pneumatic tools in damp or wet locations, or where any flammable or noxious fumes may exist. Keep work area well lighted.
5. **KEEP CHILDREN AND VISITORS AWAY.** All children and visitors should be kept at a safe distance from work area.
6. **MAKE WORKSHOP CHILD PROOF** by locking your shop and shutting off air valves.
7. **DO NOT FORCE TOOL.** It will do the job better and safer at the rate for which it was designed.
8. **USE THE RIGHT TOOL.** Do not force tool or attachment to do a job for which it was not designed.
9. **DO NOT USE UNDER THE INFLUENCE OF DRUGS OR ALCOHOL.**

WARNING

Safety Instructions for Pneumatic Tools

10. **USE PROPER AIR HOSE** for the tool. Make sure your air hose is in good condition and is long enough to reach your work without stretching.
11. **WEAR PROPER APPAREL.** Do not wear loose clothing, gloves, neckties, rings, bracelets, or other jewelry which may get caught in moving parts. Non-slip footwear is recommended. Wear a protective hair covering to contain long hair.
12. **ALWAYS USE SAFETY GLASSES.** Also use a face or dust mask if cutting operation is dusty. Everyday eyeglasses only have impact resistant lenses, they are NOT safety glasses.
13. **WEAR APPROVED HEARING PROTECTION.** Air escaping from pneumatic tools can exceed safe exposure limits and may cause hearing damage with prolonged exposure.
14. **SECURE WORK.** Use clamps or a vise to hold work when practical. It is safer than using your hand and frees both hands to operate tool.
15. **MAINTAIN TOOLS WITH CARE.** Keep tools lubricated and clean for best and safest performance. Follow instructions for lubricating and changing accessories.
16. **REDUCE THE RISK OF UNINTENTIONAL FIRING.** Do not carry tool with hand on trigger and always disconnect from air when not in use.
17. **DISCONNECT TOOLS** before servicing, changing accessories, or moving to another location.
18. **DO NOT OVERREACH.** Keep proper footing/balance at all times.
19. **USE THE RECOMMENDED ACCESSORIES.** Consult owner's manual for recommended accessories. The use of improper accessories may cause risk of injury.
20. **CHECK FOR DAMAGED PARTS BEFORE USING.** Check for binding and alignment of parts, broken parts, part mounting, loose bolts, and any other conditions that may affect machine operation. Repair or replace damaged parts.
21. **NEVER LEAVE UNATTENDED TOOL CONNECTED TO AIR.** Disconnect the air hose and do not leave tool until it is relieved of any built up pressure.
22. **NEVER ALLOW UNTRAINED USERS TO USE THIS TOOL WHILE UNSUPERVISED.**
23. **IF YOU ARE UNSURE OF THE INTENDED OPERATION, STOP USING TOOL.** Seek formal training or research books or magazines that specialize in pneumatic tools.
24. **BE AWARE OF HOSE LOCATION WHEN USING PNEUMATIC TOOLS.** Hoses can easily become a tripping hazard when laid across the floor or spread out in a disorganized fashion.

WARNING

Additional Safety Instructions for Spray Guns

1. **READ THIS MANUAL.** This manual contains proper operating instructions for this spray gun.
2. **READ MATERIAL LABELS and MATERIAL SAFETY DATA SHEETS (MSDS).** Read and know all the instructions on the packaging label and the MSDS before opening the package. This information could save your life.
3. **ALWAYS WEAR A NIOSH APPROVED RESPIRATOR WHEN SPRAYING OR WORKING AROUND FINISHING MATERIALS.**
4. **FIRE EXTINGUISHERS.** Always have a fully charged multi class or class B fire extinguisher in the immediate area.
5. **FLAMMABLE MATERIAL.** NEVER spray near open flame or where any spark could occur.
6. **FRESH AIR.** Always provide adequate exhaust to keep area free of built up vapors, NEVER spray in an enclosed space.
7. **DISCONNECT COMPRESSED AIR.** Always disconnect the spray gun from compressed air before cleaning, changing attachments or when performing maintenance of any kind on this tool.
8. **PROTECTIVE CLOTHING.** Protect exposed skin from overspray by wearing a protective suit or other approved garment.
9. **UNSAFE USE.** DO NOT point or shoot spray gun directly at yourself or another person or animals. Do not attempt to use the spray gun for any other use than it was intended.
10. **STORAGE.** Thoroughly clean and dry spray gun before storage. Store in an approved cabinet.
11. **SOLVENTS.** Always store solvents and shop towels soaked in solvent in approved containers.
12. **EYE PROTECTION.** Wear eye protection whenever spraying or cleaning. Solvents and chemicals can cause serious eye injury, which could lead to blindness.
13. **OPERATING PRESSURE.** DO NOT exceed the recommended inlet air pressure. Excessive pressure could cause the spray gun to burst or cause other internal equipment damage.
14. **LOCAL LAWS.** Consult local authorities regarding exhaust and waste disposal requirements.

CAUTION

No list of safety guidelines can be complete. Every shop environment is different. Always consider safety first, as it applies to your individual working conditions. Use this and other tools with caution and respect to avoid serious injury.

INTRODUCTION

Woodstock Technical Support

This tool has been specially designed to provide many years of trouble-free service. Close attention to detail, ruggedly built parts and a rigid quality control program assure safe and reliable operation.

Woodstock International, Inc. is committed to customer satisfaction. Our intent with this manual is to include the basic information for safety, setup, operation, maintenance, and service of this product.

We stand behind our tools! In the event that questions arise about your tool, please contact Woodstock International Technical Support at (360) 734-3482 or send e-mail to: tech-support@shopfox.biz. Our knowledgeable staff will help you troubleshoot problems and process warranty claims.

If you need the latest edition of this manual, you can download it from <http://www.shopfox.biz>.

If you have comments about this manual, please contact us at:

**Woodstock International, Inc.
Attn: Technical Documentation
Manager**

P.O. Box 2309

Bellingham, WA 98227

Email: manuals@woodstockint.com

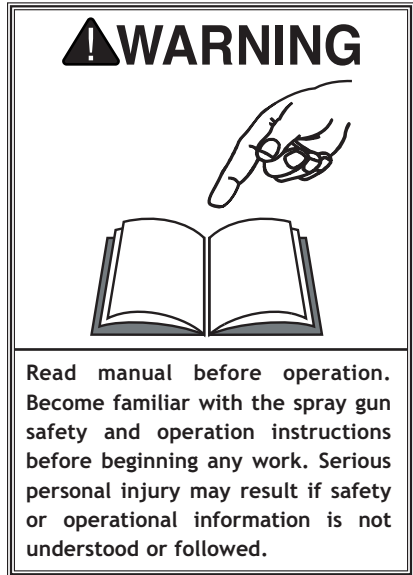

SETUP

Unpacking

This tool has been carefully packaged for safe transportation. If you notice the machine has been damaged during shipping, please contact your authorized Shop Fox dealer immediately.

Inventory

The following is a description of the main components shipped with the Model D3274. Lay the components out to inventory them.

Note: *If you can't find an item on this list, check the mounting location on the tool or examine the packaging materials carefully. Occasionally we pre-install certain components for safer shipping.*

D3274 Inventory (Figure 1)	Qty
A. Material Cup	1
B. Air Regulator.....	1
C. Spray Gun	1
D. Service Wrench.....	1
E. Hex Socket Tool	1
F. Filter	1
G. Cleaning Brush.....	1

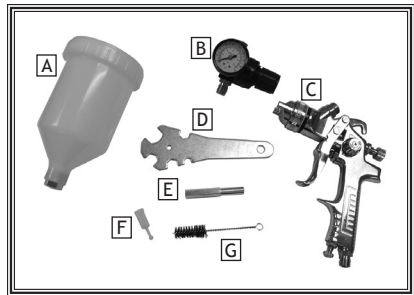

Figure 1. Model D3274 inventory.

Specifications

Operating Air Pressure	30-50 PSI
Maximum Air Pressure.....	70 PSI
Material Cup Capacity.....	600 CC
Air Consumption	4.2-7.1CFM
Maximum Fluid Pressure	10 PSI
Cup Material	Plastic
Body Material.....	Aluminum Alloy
Maximum Pattern Width	250mm
Water-Based Material Compatible	Yes
Weight	1.5 lbs.

Assembly

1. Insert the filter into the gun body with the knob pointing outward (see Figure 2).

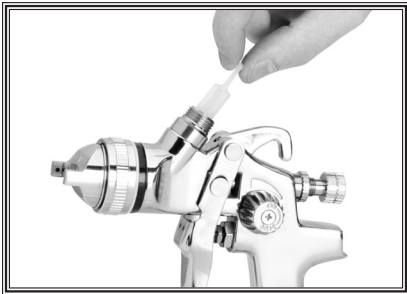

Figure 2. Installing filter.

2. Screw the cup onto the top of the body.
3. Attach the regulator to the bottom of the spray gun.
4. Attach the air hose to the spray gun regulator with a 1/4" NPT quick connect fitting (not included).
5. Attach the spray gun to an air supply regulated between 30 and 50 PSI.

Note: For the best results, use a hose that will be dedicated for spray use only. Do not use a hose that has been used with an in-line oiler or other possible contaminant.

Controls

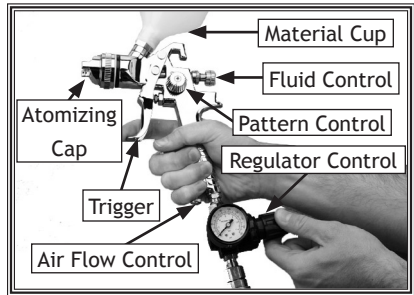

Figure 3. Controls.

- **Fluid Control:** Controls the volume of material that travels through the fluid tip by adjusting how far the trigger can be pulled back.
- **Pattern Control:** Adjusts the spray pattern from a round pattern to a wide fan.
- **Air Flow Control:** Adjusts the fluid pressure inside the spray gun.
- **Atomizing Cap:** Adjusts the spray pattern from vertical to horizontal.
- **Trigger:** Two stage trigger. Stage one only releases compressed air for blowing off the work piece. Stage two sprays material.
- **Material Cup:** Holds the paint to be sprayed.
- **Regulator/Gauge:** Regulates inlet air pressure to the spray gun. It can be attached directly to the gun for on-the-spot air adjustments or to the air source.

Note: DO NOT attach the spray gun or regulator control to an unregulated air source that exceeds 120 PSI.

OPERATIONS

Spraying

The Model D3274 HVLP (high volume, low pressure) spray gun set is designed to spray a wide variety of materials like lacquers, stains, primers, multi-component paints, clear coats, acrylics, epoxies etc. It is ideal for auto body and woodworking projects.

To use your spray gun:

1. Read and follow the material manufacturer's instructions for spraying, reducing, safety, disposal, and any other instruction on the label or Material Safety Data Sheet (MSDS).
2. Ensure the cup is securely tightened and all other fittings are secure to avoid air leaks or material spills.
3. Use the regulator control (**Figure 3**), to set the inlet air pressure to 30 PSI or to the material manufacturer's recommendations (not to exceed 70 PSI).
4. Adjust the atomizing cap (**Figure 3**) for a vertical or horizontal spray pattern. Refer to **Atomizing Cap and Fan Adjustments** on **Page 9** for further explanation.
5. After the material has been reduced to the manufacturer's specifications, fill the cup with the thinned material.
6. Trial and error, along with a fair amount of practice are necessary to achieve the results you want. Test your material flow and spray pattern on a piece of cardboard or some scrap of material similar to your project.

⚠ DANGER

EXPLOSION HAZARD! DO NOT smoke or have any source of flame or spark near spraying. Vapors will explode if ignited.

⚠ WARNING

RESPIRATORY HAZARD! Always use respirator rated for organic vapor and solvent use when using spray equipment. Failure to protect your lungs can lead to respiratory illness and nervous system damage.

⚠ WARNING

TOXIC FUMES! Always use an approved spray booth or well ventilated area when spraying. **NEVER** spray in a confined space where toxic fumes and flammable vapors can accumulate to deadly levels.

- Adjust the fluid control knob (**Figure 3**), to start with a low volume of material and keep the atomization as low as possible. You will need to use a combination of fluid control, inlet air pressure, air flow control and stroke speed to achieve the results you want. Spray so the material wets out nicely without running or sagging.
- Use the pattern control knob (**Figure 3**), to adjust the spray fan to your desired pattern.
- Keep the gun tip perpendicular to the ground, parallel to the spraying surface, and 6-8" from the work (as shown in **Figure 4**) when spraying. Do not allow your wrist to bend. This will cause the gun to arc across the surface and distribute the material unevenly, possibly creating sags and dry spots.

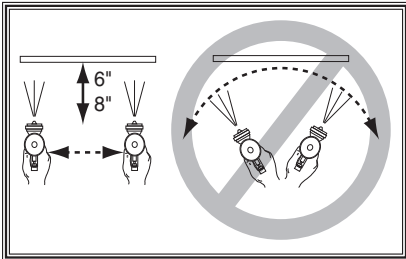

Figure 4. Spray technique.

NOTICE

Tipping spray gun may cause material to spill out of the cup. Always hold the spray gun perpendicular to the ground to avoid potential spills and gravity feed problems.

- Begin spraying 2-3 inches before the work and continue to the end of the work, as shown in **Figure 5**. Continue the motion for a few inches past the work until you are ready for the return stroke.

Note: Trigger position **B** (**Figure 5**) introduces air to the paint gun, so that position **C** (spray), is dust, spatter, and cloud free.

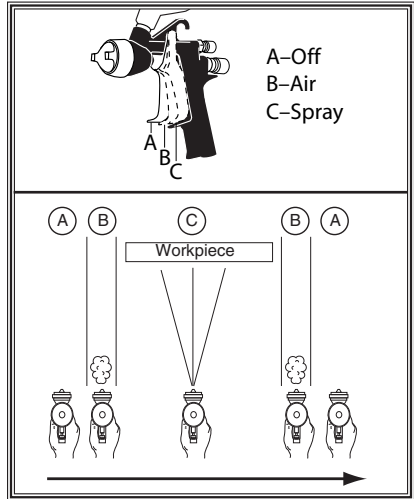

Figure 5. Spray positions.

- Overlap each stroke by 50% while maintaining an even speed. This will ensure even coverage as shown in **Figure 6**. Overlapping less than 50%, as shown in the figure to the right, may lead to missed spots or streaky results.

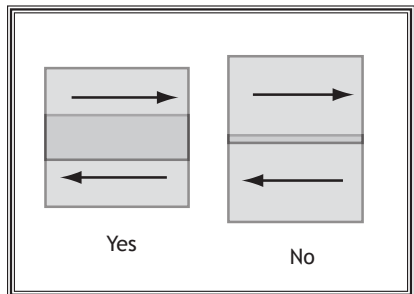

Figure 6. Overlap technique.

- Spray stroke should have even consistency and parallel edges. If it doesn't, refer to **Troubleshooting on Page 12**.

Atomizing Cap and Fan Adjustments

The atomizing cap needs to be adjusted for horizontal or vertical spraying patterns. Spraying in the wrong direction may lead to material build up on the atomizing cap horn. Many performance problems with properly thinned paint are caused by clogged atomizing holes on the atomizing cap horns (see **Cleaning** on **Page 10**).

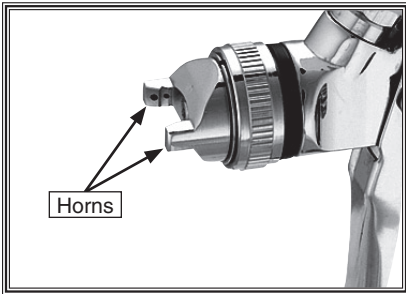

Figure 7. Atomizing cap horns.

Rotating the pattern adjustment control in **Figure 8** and **9** will give you a range between the two patterns in **Figure 10**.

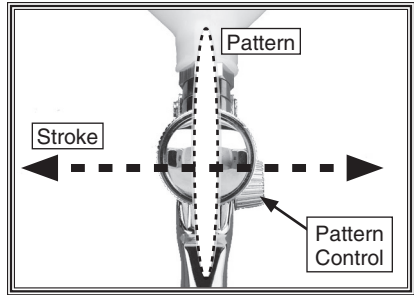

Figure 8. Set up for horizontal spray stroke with vertical fan pattern.

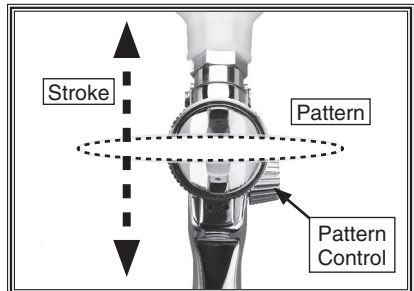

Figure 9. Set up for vertical spray stroke with horizontal fan pattern.

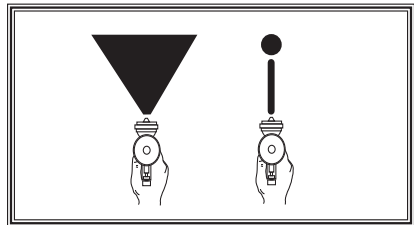

Figure 10. Fan pattern adjustment.

CLEANING & LUBRICATION

WARNING



EYE INJURY! Always wear safety glasses when disassembling the spray gun. The material cup may still be pressurized. Parts may also shoot out of the gun pressure is released from the springs.

Cleaning

Proper cleaning is the best way to ensure trouble-free performance from your spray gun. If your gun is not thoroughly cleaned, damage and poor spraying will result. Problems caused by improper cleaning will not be covered by the warranty. Clean the spray gun immediately after each use.

Basic spray gun cleaning:

1. Spray a small amount of solvent through the spray gun.

Note: Check with local laws regarding this practice. If you are spraying on a regular basis, spraying solvents into the air may be illegal. A cabinet style spray gun cleaner may be required.

2. DISCONNECT THE SPRAY GUN FROM AIR!
3. Put on safety glasses and unscrew the cup.

4. Disassemble the gun by unscrewing the fluid control knob by hand, and removing the spring and needle (Figure 9).

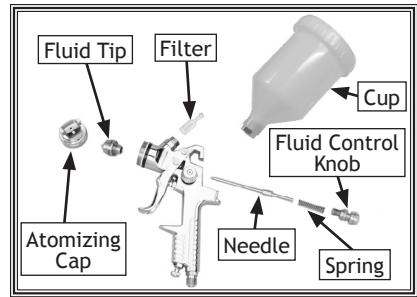

Figure 11. Disassembly for cleaning.

5. Unscrew the atomizing cap with your fingers and the fluid tip with the service wrench (Figure 1). The fully disassembled gun should look like Figure 9.
6. Rinse these parts thoroughly in solvent then dry with compressed air or let air dry.

Note: If the small holes in the atomizing cap become blocked, soak them in clean solvent. If the blockage still exists, clear it with a small needle, taking great care not to enlarge or damage the hole. Damage to the hole will create a disrupted spray pattern.

7. Use the cleaning brush with solvent to clean the inner orifice and other hard to reach areas on the outside of the spray gun body.
8. Wipe the rest of the gun body with a shop towel and dry.

Depending on the amount of use and the type of material used, the spray gun may need to be disassembled and cleaned beyond what is mentioned on **Page 10**. If spray patterns become affected due to internal blockages or the gun will be stored for an extended amount of time, follow these additional cleaning instructions.

Advanced spray gun cleaning:

1. Follow **Steps 1-5** on **Page 10**.
2. Insert the bigger end of the hex socket tool into the head of the disassembled spray gun. Use the service wrench on the end of the hex socket tool as a lever to remove the fluid nozzle plug and seals, as shown in **Figure 10**.
3. Insert the smaller end of the hex socket tool into the head of the spray gun. Use the service wrench on the end of the hex socket tool as a lever to remove the screw and spring.
4. Follow **Steps 6-8** on **Page 10**.

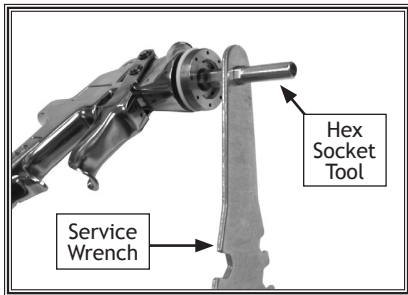

Figure 12. Removing fluid nozzle plug.

⚠ WARNING

EXPLOSION HAZARD! Chlorinated Solvents like Trichloroethane and Methylene Chloride (methyl chloride) can chemically react with aluminum and may explode. Many parts in spray guns are made of aluminum. Read solvent label carefully before using solvent.

NOTICE

DO NOT soak the spray gun body in solvent. Prolonged exposure to solvent will rapidly deteriorate the spray gun washers and seals. Ignoring this notice will void your warranty.

Lubrication

Lubricate the following areas with spray gun lube after cleaning:

- A. Atomizing Cap Threads
- B. Air Valve Packing
- C. Trigger Pin
- D. Air Flow Control Valve
- E. Pattern Control
- F. Fluid Control Knob

After each cleaning, apply a thin film of petroleum jelly to the needle spring before reassembling.

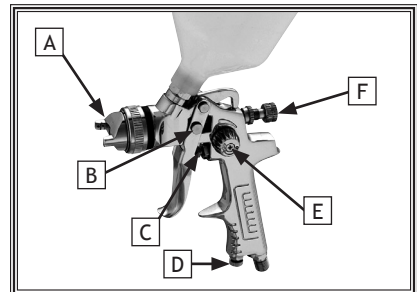







Figure 13. Lubrication points.

Troubleshooting

NOTICE

Before Troubleshooting, make sure your paint is properly thinned or reduced according to the instructions given by the paint manufacturer.

Symptom	Possible Cause	Possible Solution
Fluttering or Spitting spray. 	<ol style="list-style-type: none"> 1. Dry or worn fluid tip seat permits air to seep into fluid passage. 2. Material level too low. 3. Fluid tip or strainer obstructed. 4. Dry needle packing. 	<ol style="list-style-type: none"> 1. Tighten fluid tip or replace seat with new one. 2. Add material. 3. Clean. 4. Lubricate needle.
Uneven top or bottom pattern. 	<ol style="list-style-type: none"> 1. Atomizing cap holes are obstructed. 2. Build-up on top or bottom of fluid tip. 3. Build-up on atomizing cap is on needle seat. 	<ol style="list-style-type: none"> 1. Clear holes. 2. Clean. 3. Clean.
Right or left arc pattern. 	<ol style="list-style-type: none"> 1. Left or right side horn holes are plugged. 2. Build-up on left or right side of fluid tip. 3. Build-up of material inside atomizing cap. 	<ol style="list-style-type: none"> 1. Clear holes. 2. Clean. 3. Clean.
Heavy deposit of material in center. 	<ol style="list-style-type: none"> 1. The material flow exceeds the atomizing cap capacity. 2. Inlet air pressure is too low. 3. Material is too thick. 	<ol style="list-style-type: none"> 1. Lower fluid flow. 2. Increase inlet air pressure. 3. Thin material.
Narrow center pattern. 	<ol style="list-style-type: none"> 1. Volume control turned in too far. 2. Inlet air pressure too high. 3. Fluid pressure is too low. 4. Material is too thin. 	<ol style="list-style-type: none"> 1. Increase volume. 2. Reduce inlet air pressure. 3. Increase fluid pressure. 4. Adjust material.
No spray output.	<ol style="list-style-type: none"> 1. No pressure at gun. 2. Fluid passages dirty. 3. Fluid control closed. 4. Out of paint. 	<ol style="list-style-type: none"> 1. Check air supply. 2. Clean gun, remove any obstructions. 3. Open. 4. Refill.

Symptom	Possible Cause	Possible Solution
Excessive over-spray.	<ol style="list-style-type: none"> 1. Fluid pressure too high. 2. Gun is too far from surface. 3. Spraying too fast. 	<ol style="list-style-type: none"> 1. Reduce fluid pressure. 2. Keep gun at recommended distance. 3. Slow down and maintain consistent, even parallel stroke.
Unable to control spray fan.	<ol style="list-style-type: none"> 1. Pattern adjustment screw is not seating properly. 2. Atomizing cap is loose. 	<ol style="list-style-type: none"> 1. Clean or replace. 2. Tighten atomizing cap.
Runs and sags.	<ol style="list-style-type: none"> 1. Spraying too slowly. 2. Gun is too close to surface. 3. Damaged seal. 	<ol style="list-style-type: none"> 1. Adjust spraying speed. 2. Adjust spraying distance to 6-8" from surface. 3. Replace damaged seals.
Material leaks from cup.	<ol style="list-style-type: none"> 1. Cap not secure. 2. Cup not tight on gun body. 3. Leaking from cap vent hole. 	<ol style="list-style-type: none"> 1. Tighten. 2. Tighten. 3. Hold gun upright do not tilt.
Material leaks from gun.	<ol style="list-style-type: none"> 1. Fluid tip loose. 2. Dry or damaged seals. 3. Excessive pressure. 	<ol style="list-style-type: none"> 1. Tighten. 2. Replace seals. 3. Reduce pressure.
Thick dimpled finish aka "Orange Peel."	<ol style="list-style-type: none"> 1. Holding gun too close to surface. 2. Inlet air pressure too low. 3. Material not properly mixed. 4. Surface is dirty or oily. 	<ol style="list-style-type: none"> 1. Spray at recommended distance. 2. Check inlet air pressure. 3. Follow manufacturer's instructions. 4. More surface prep is required.
Dry Spray.	<ol style="list-style-type: none"> 1. Inlet air pressure too high. 2. Gun too far from surface. 3. Gun stroke too fast. 	<ol style="list-style-type: none"> 1. Lower inlet air pressure. 2. Keep gun at recommended distance. 3. Slow down and maintain consistent even parallel stroke.
Gun leaks from fluid tip.	<ol style="list-style-type: none"> 1. Debris will not let the needle seat with the fluid tip. 	<ol style="list-style-type: none"> 1. Clean or replace both.
Contaminated paint.	<ol style="list-style-type: none"> 1. Water or oil in the air line. 	<ol style="list-style-type: none"> 1. Install an in-line air filter. 2. Replace air line. 3. Spray gun filter is missing.

D3274 PARTS BREAKDOWN

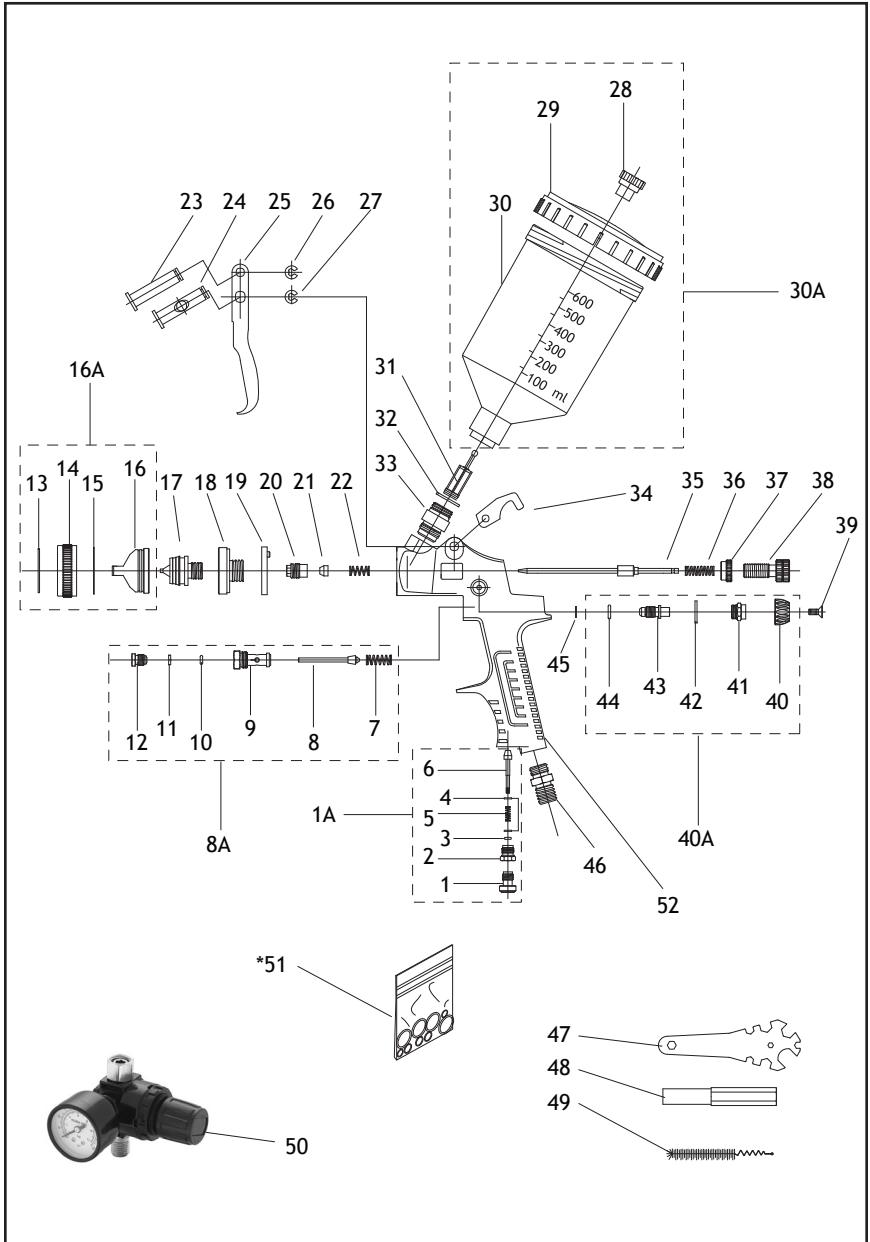

* Not Included; for aftermarket purchase only

D3274 PARTS LIST

REF	PART #	DESCRIPTION	REF	PART #	DESCRIPTION
1A	XD3274001A	AIR INLET VALVE ASSEMBLY	27	XPEC02M	E-CLIP 4MM
1	XD3274001A	AIR ADJ. SCREW	28	XD3274030A	BREATHER PLUG
2	XD3274001A	AIR ADJ. KNOB	29	XD3274030A	CONTAINER COVER
3	XD3274001A	O-RING 2.5 X 2.1	30A	XD3274030A	CONTAINER ASSEMBLY
4	XD3274001A	DOMED SEAL WASHER	30	XD3274030A	CONTAINER
5	XD3274001A	AIR ADJ. SPRING	31	XD3277022	FILTER
6	XD3274001A	AIR INLET VALVE	32	XD3274032	FLUID INLET JOINT SEAL
7	XD3274008A	SWITCH SPRING	33	XD3277023	FLUID INLET JOINT
8A	XD3274008A	AIR VALVE BODY ASSEMBLY	34	XD3274034	HANGER
8	XD3274008A	AIR VALVE BODY	35	XD3274035	FLUID ADJ. NEEDLE
9	XD3274008A	SWITCH KNOB	36	XD3277033	COMPRESSION SPRING 6 X 37
10	XD3274008A	O-RING 2.4 X 1.8	37	XD3277032	JOINT CAP
11	XD3274008A	DOMED SEAL WASHER	38	XD3274038	FLUID ADJ. KNOB
12	XD3274008A	DIRECTION SCREW	39	XPFH31M	FLAT HD SCR M4-.7 X 8
13	XD3274016A	LOCKED SPRING	40A	XD3274040A	PATTERN ADJ. KNOB ASSEMBLY
14	XD3274016A	NOZZLE NUT	40	XD3274040A	PATTERN ADJ. KNOB
15	XD3274016A	SEAL WASHER 30MM	41	XD3274040A	PATTERN ADJ. KNOB
16A	XD3274016A	ATOMIZER ASSEMBLY	42	XD3274040A	COPPER WASHER 8MM
16	XD3274016A	ATOMIZER	43	XD3274040A	PATTERN ADJ. SCREW
17	XD3277008	FLUID NOZZLE	44	XPOR0062	O-RING 6 X 2
18	XD3277009	FLUID NOZZLE PLUG	45	XPEC09M	E-CLIP 6MM
19	XD3277010	SEAL WASHER 10MM	46	XD3277041	AIR INLET 1/4" NPT
20	XD3277011	DIRECTION SCREW M11-1 X 7	47	XD3277042	MULTI-TOOL WRENCH
21	XD3277012	DOMED SEAL WASHER 3.5	48	XD3277043	HEX SOCKET TOOL
22	XD3277013	COMPRESSION SPRING 6.3 X 14	49	XD3277044	CLEANING BRUSH
23	XD3274023	TRIGGER PIN I	50	XD3274050	AIR REGULATOR
24	XD3274024	TRIGGER PIN II	*51	XD3274051	O-RING KIT
25	XD3274025	TRIGGER	52	XD3274052	GUN BODY
26	XPEC02M	E-CLIP 4MM			

WARRANTY AND RETURNS

Woodstock International, Inc. warrants all Shop Fox machinery to be free of defects from workmanship and materials for a period of two years from the date of original purchase by the original owner. This warranty does not apply to defects due directly or indirectly to misuse, abuse, negligence or accidents, lack of maintenance, or reimbursement of third party expenses incurred.

Woodstock International, Inc. will repair or replace, at its expense and at its option, the Shop Fox machine or machine part which in normal use has proven to be defective, provided that the original owner returns the product prepaid to a Shop Fox factory service center with proof of their purchase of the product within two years, and provides Woodstock International, Inc. reasonable opportunity to verify the alleged defect through inspection. If it is determined there is no defect, or that the defect resulted from causes not within the scope of Woodstock International Inc.'s warranty, then the original owner must bear the cost of storing and returning the product.

This is Woodstock International, Inc.'s sole written warranty and any and all warranties that may be implied by law, including any merchantability or fitness, for any particular purpose, are hereby limited to the duration of this written warranty. We do not warrant that Shop Fox machinery complies with the provisions of any law or acts. In no event shall Woodstock International, Inc.'s liability under this warranty exceed the purchase price paid for the product, and any legal actions brought against Woodstock International, Inc. shall be tried in the State of Washington, County of Whatcom. We shall in no event be liable for death, injuries to persons or property or for incidental, contingent, special or consequential damages arising from the use of our products.

Every effort has been made to ensure that all Shop Fox machinery meets high quality and durability standards. We reserve the right to change specifications at any time because of our commitment to continuously improve the quality of our products.

Warranty Registration

Name _____

Street _____

City _____ State _____ Zip _____

Phone # _____ Email _____ Invoice # _____

Model # _____ Serial # _____ Dealer Name _____ Purchase Date _____

The following information is given on a voluntary basis. It will be used for marketing purposes to help us develop better products and services. Of course, all information is strictly confidential.

1. How did you learn about us?

Advertisement _____ Friend _____ Local Store _____
Mail Order Catalog _____ Website _____ Other: _____

2. How long have you been a woodworker/metalworker?

0-2 Years _____ 2-8 Years _____ 8-20 Years _____ 20+ Years _____

3. How many of your machines or tools are Shop Fox?

0-2 _____ 3-5 _____ 6-9 _____ 10+ _____

4. Do you think your machine represents a good value? _____ Yes _____ No

5. Would you recommend Shop Fox products to a friend? _____ Yes _____ No

6. What is your age group?

20-29 _____ 30-39 _____ 40-49 _____
50-59 _____ 60-69 _____ 70+ _____

7. What is your annual household income?

\$20,000-\$29,000 _____ \$30,000-\$39,000 _____ \$40,000-\$49,000 _____
\$50,000-\$59,000 _____ \$60,000-\$69,000 _____ \$70,000+ _____

8. Which of the following magazines do you subscribe to?

<input type="checkbox"/> Cabinet Maker	<input type="checkbox"/> Popular Mechanics	<input type="checkbox"/> Today's Homeowner
<input type="checkbox"/> Family Handyman	<input type="checkbox"/> Popular Science	<input type="checkbox"/> Wood
<input type="checkbox"/> Hand Loader	<input type="checkbox"/> Popular Woodworking	<input type="checkbox"/> Wooden Boat
<input type="checkbox"/> Handy	<input type="checkbox"/> Practical Homeowner	<input type="checkbox"/> Woodshop News
<input type="checkbox"/> Home Shop Machinist	<input type="checkbox"/> Precision Shooter	<input type="checkbox"/> Woodsmith
<input type="checkbox"/> Journal of Light Cont.	<input type="checkbox"/> Projects in Metal	<input type="checkbox"/> Woodwork
<input type="checkbox"/> Live Steam	<input type="checkbox"/> RC Modeler	<input type="checkbox"/> Woodworker West
<input type="checkbox"/> Model Airplane News	<input type="checkbox"/> Rifle	<input type="checkbox"/> Woodworker's Journal
<input type="checkbox"/> Modeltec	<input type="checkbox"/> Shop Notes	<input type="checkbox"/> Other: _____
<input type="checkbox"/> Old House Journal	<input type="checkbox"/> Shotgun News	

9. Comments: _____

CUT ALONG DOTTED LINE

FOLD ALONG DOTTED LINE

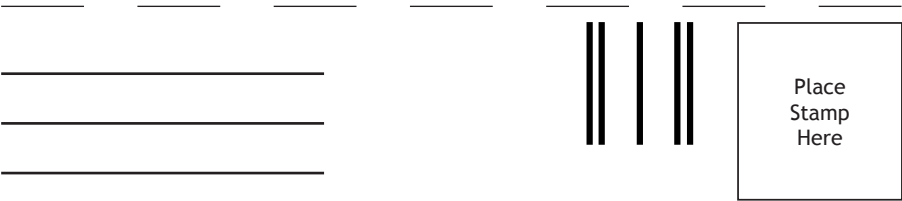

WOODSTOCK INTERNATIONAL INC.
P.O. BOX 2309
BELLINGHAM, WA 98227-2309



FOLD ALONG DOTTED LINE

TAPE ALONG EDGES--PLEASE DO NOT STAPLE